



Dragon Class Chinese Ranges by Town:
Models E, EF, Y, YF, M, MF

Express YORK MASTER RANGE
THE WORLD'S FINEST CHINESE COOKING EQUIPMENT

OWNER'S MANUAL
SECTION I: INSTALLATION INSTRUCTIONS



For units shipped after June 2005 with new flue design

WARNING

IMPROPER INSTALLATION, ADJUSTMENT, ALTERATION, SERVICE OR MAINTENANCE CAN CAUSE PROPERTY DAMAGE, INJURY OR DEATH. READ THE INSTALLATION, OPERATING AND MAINTENANCE INSTRUCTIONS THOROUGHLY BEFORE INSTALLING OR SERVICING THIS EQUIPMENT.



FOR YOUR SAFETY

DO NOT STORE OR USE GASOLINE OR OTHER FLAMMABLE VAPORS AND LIQUIDS IN THE VICINITY OF THIS OR ANY OTHER APPLIANCE.

NOTE

OBTAIN EMERGENCY PROCEDURES FROM YOUR LOCAL GAS SUPPLIER IF YOU SMELL GAS NEAR THIS EQUIPMENT. THIS EMERGENCY INFORMATION MUST BE PROMINENTLY DISPLAYED.

KEEP THIS BOOKLET HANDY FOR FUTURE REFERENCE



TOWN
FOOD SERVICE EQUIPMENT CO., INC.



72 Beadel St., Brooklyn, NY 11222
(718) 388-5650 fax (718) 388-5860
customerservice@townfood.com

CONGRATULATIONS

on your purchase of the new Dragon Class Express, York or MasteRRange. It will give you many years of trouble free use if it is properly used and maintained. Feel free to call our Customer Service Department if you have questions regarding operation or care of your Town range.

INSTALLATION INSTRUCTIONS Express, YORK and MASTERRANGE DRAGON SERIES CHINESE RANGES

Your Dragon class range has been carefully engineered and constructed with the best possible workmanship and materials to provide many years of satisfactory service. Proper installation is vital if appearance and performance is to be achieved.

FOLLOW THESE INSTRUCTIONS CAREFULLY!

Express/YORK/MASTERRANGE INSTALLATION AREA MUST BE FREE AND CLEAR FROM COMBUSTIBLES

1. Position crate in approximate location that the unit will occupy. Uncrate range and locate sealed cartons on the range top containing the following accessories: One (1) set of adjustable legs; one (1) drip pan for each chamber; and one (1) extension chimney for each opening in returnsplash if your unit is equipped with a flue riser. "E" units do not have a flue riser and the chimney extension is not a part of these ranges. Find the legs and set one leg by each range gusset into which it will be inserted. Raise one end of the unit at a time; insert legs; and tighten set screws with 1/4" Allen wrench. If your range has flue risers, slip the extension chimney over each riser.
2. Range is now ready for final positioning. Carefully lift range into desired position to avoid damage to adjustable legs. Clearances from combustible construction are 6" at rear and sides. Remove burner tie wires and other packing materials. Check gas burners that may have shifted in transit and center them by eye if required. Turn all gas valve lever handles to "OFF" (horizontal) position. Check air mixer alignment to gas burner nipple and tighten set screws if necessary.
3. Clearances for noncombustible construction are the same as combustible clearances. This range is for installation only on noncombustible floors.

INSTALLATION:

1. The gas supply line must be of adequate size to insure maximum efficiency of the unit.
2. The installation must conform with the National Fuel Gas Code, ANSI Z223.1, Natural Gas Installation Code, CAN/CGA-B149.1 or the Propane Installation Code, CAN/CGA-B149.2, as applicable, including:
 - a. The appliance and its individual shutoff valve must be disconnected from the gas supply piping system during any pressure testing of that system at test pressures in excess of 1/2 psi (3.45 kPa).
 - b. The appliance must be isolated from the gas supply piping system by closing its individual manual valve during any pressure testing of the gas supply piping system at test pressures equal or less than 1/2 psig (3.45 kPa).

3. Local regulations governing gas appliance installations must be complied with.
4. Equipment should be under hood with adequate ventilation.
5. Minimum spacing of 6" to combustible construction is required along back and side walls. Clearances for noncombustible construction are the same as combustible clearances. For use only on noncombustible floors.
6. Materials such as wood, compressed paper and plant fibers that will ignite and burn, Must Not Be Exposed Near Range Especially at Rear. Local safety codes should be complied with in respect to fire hazard avoidance.
7. Use of the supplied pressure regulator is mandatory.
8. The front of the unit must be kept clear to avoid restriction of air supply for combustion.
9. The unit must be installed in an area or room with sufficient fresh air supply to ensure proper combustion.
10. There must be adequate clearance for air openings into the combustion chamber.
11. This equipment must be installed with adequate clearance for servicing and proper operation.
12. This unit should be operated only with drip trays in place.
13. If your unit is supplied with casters, the installation shall be made with a connector that complies with the Standard for Connectors for Movable Gas Appliances, ANSI Z21.69 or Connectors for Moveable Gas Appliances, CAN/CGA-6.16, and a Quick Disconnect device that complies with the Standard for Quick-Disconnect Devices for Use with Gas Fuel ANSI Z21.41, or Quick Disconnect Devices for Use with Gas Fuel, CAN1-6.9, and adequate means must be provided to limit the movement of the appliance without depending on connector and the quick-disconnect device or its associated piping to limit the appliance movement.
14. If your unit is provided with casters on legs, the legs with locking casters must be installed in front of the unit. An approved restraining device must be secured to unit rear or side.

IMPORTANT

1. Before connecting gas and water supply, the range deck must be pitched so water will drain off range top into the gutter, and into the internal or external slop sink.
2. Range deck pitch is adjusted by raising or lowering each leg as necessary at the adjustable foot. Raise front legs or lower rear legs of the unit to provide pitch for water to drain into gutter at rear. Ranges with external sinks: Observe that water drains out of gutter at open end. If water remains in gutter, lower legs on discharge end, or raise legs at opposite end.
3. Connect the gas supply line to unit using the pressure regulator provided. A readily accessible approved type gas shutoff should be supplied by others. Water supply line on back of unit and sprinkler should be connected with a shutoff valve in readily accessible location.
4. Check that all gas valves on the unit are turned "OFF" (lever handles in horizontal position) before turning "ON" main gas line. Check for leaks using soapy water or other suitable leak detector. DO NOT USE OPEN FLAME FOR TESTING. Check that swing faucets and sprinkler valve are in "OFF" position (spout parallel to backsplash), open water valve and check for leaks.

5. UNITS WITHOUT SAFETY VALVES: LIGHTING AND SHUT DOWN INSTRUCTIONS

Be sure that all piping is gas tight and that all air is purged from lines. With Main Burner Valve in "OFF" position (see fig.2), using a screw driver turn pilot screw counter clockwise to "ON" (see fig. 1) and light

pilot located in the combustion chamber. Make sure the pilot stays lit.

All units are equipped with fixed orifices which cannot be adjusted for gas flow. Only ring burners have adjustable air mixers to adjust the air/gas mixture.

Turn right hand burner valve to full "ON" position (see fig.2) and adjust air shutter until proper blue flame is burning on both inner rings. Repeat operation for left hand valve only if your range is equipped with three ring burners.

SHUTDOWN: Turn burner valves to "OFF" position (see fig.2) and turn the pilot screw clockwise (see fig. 1) until it cannot be turned further. Repeat this step for each chamber.

OPERATING INSTRUCTIONS

1. INSTALLATION AREA MUST BE FREE AND CLEAR FROM COMBUSTIBLES. Local safety codes should be complied with in respect to fire avoidance.

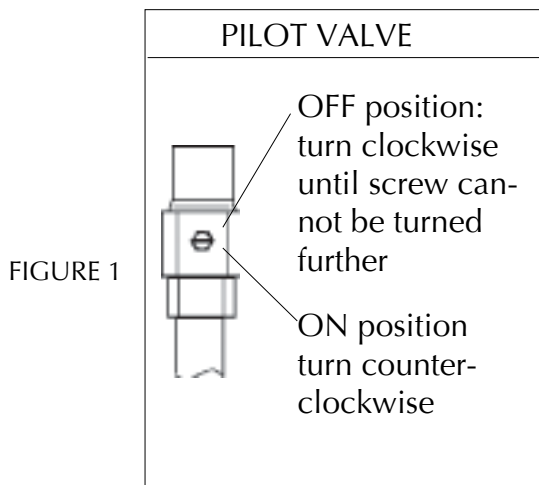

FIGURE 1

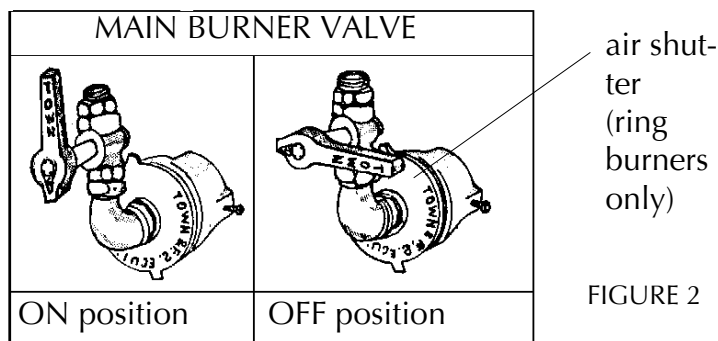

FIGURE 2

6. UNITS WITH SAFETY VALVES: LIGHTING AND SHUT DOWN INSTRUCTIONS.

Always follow these lighting and shutdown instructions when operating your unit. A five minute complete shutoff period is required before lighting or relighting pilot. See diagram below.

- a) Check that all gas valves on the unit are turned "OFF" (lever handles in horizontal position) before turning "ON" main gas line. Check for leaks using soapy water or other suitable leak detector. DO NOT USE OPEN FLAME FOR TESTING.
- b) Main burner valve shall be in "OFF" position (figure 2). Place a burning match by the pilot burner in the combustion chamber of the range. Depress safety control red button on (fig.1 below) and light pilot.
- c) The pilot should light. Continue to hold the button for one minute or until the pilot stays lit.

SHUT DOWN: For temporary Shut Down turn all burner valves to "OFF" position. For an extended period of time, turn all burner valves "OFF" and also turn off gas supply to the range.

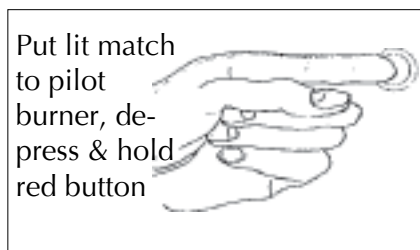

figure 1

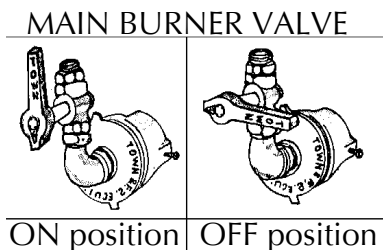
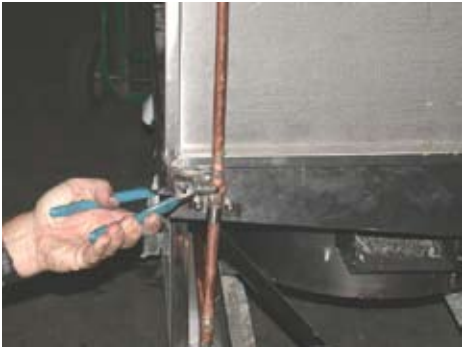

figure 2

BACKSPLASH REMOVAL & REINSTALLATION

Some installations require the backsplash to be removed so the range can fit through a 34" door. Town ranges are manufactured with removable backsplashes. Follow these steps:



1. Loosen union at backsplash



5. Sidesplash may be removed. Range will fit through 34" opening.



2. Remove sidesplash bolts and lower backsplash

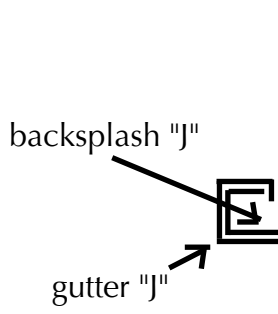

6. Reinsert sidesplash and backsplash into gutter. Insure backsplash "J" hooks into gutter "J".

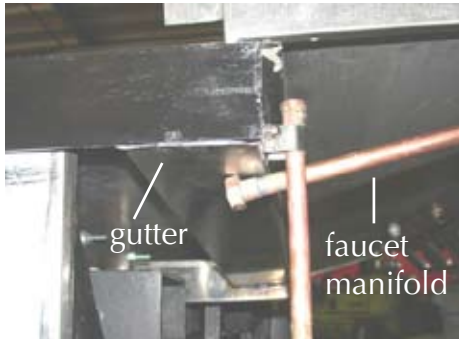

3. Faucet manifold must be placed below gutter



7. Raise backsplash, making sure it is locked into the gutter "J".



4. Lower backsplash until sidesplash clears gutter



8. When raised, the gutter and backsplash should be aligned. Bolt side splashes to body.

FLUE RISER EXTENSION INSTALLATION (NEW VERSION ON UNITS SHIPPED AFTER JUNE 2005)

Ranges with optional Flue Risers have stainless steel extensions that cover the tops of the flue risers. Locate the parts in the boxed marked "range accessories". To install them:



figure 1



figure 3

1. Take assembled flue collar and turn with kink to rear (figure 1).

3. Catch front return beneath slot in back splash (circled in figure 3).



figure 2



figure 4

2. Place flue collar on top of chimney extension as illustrated (figure 2).

4. Snap kinked end into slot (figure 4).

FIELD JOINT INSTALLATIONS

The optional Field Joint joins two or more ranges. It must be ordered when the ranges are built. It cannot be added to existing ranges. A Butt Field Joint has a standing seam between ranges while a Splice Field Joint gives a smooth fit.

BUTT FIELD JOINT INSTALLATION INSTRUCTIONS

Each range has a vertical seam at the joint between the ranges. The backsplashes will be joined.

1. Uncrate the ranges and install legs onto the gussets. Secure legs with the gusset set screw.

3. One of the ranges will have a hooked lip to overlap the adjoining range. Raise the range with the hooked lip and place it over the adjoining range with the straight lip. See figures 2 & 3.

2. Carefully locate the battery into final location. Remove the serving shelf. Align the sides to be joined. The battery was assembled at the factory to assure good fit. Pitched floors will add difficulty to battery assembly. See figure 1.



figure 1



figure 2



figure 3



figure 6



figure 4



figure 7



figure 5



figure 8

4. Align the backsplashes. It may necessary to level the range so the backsplashes meet at top. Insert and slide down the "U" shaped joiner until it is level with the top of the backsplash. See figure 4.

5. Install the stainless tubular wok cover rack. Male and female ends mate to become a continuous length. Remove the bolts from the brackets and install the tubing with threaded ends. Use the bolts removed from the brackets at the endsplashes. See figures 5-7.

6. Install the serving shelf. The range position may have to be adjusted to align the bolt holes in the serving shelf with the tapped holes provided for them. See figures 8 & 9.



figure 9

6. Pitch the range using the adjustable bullet feet so that water flows off the top of the range.

7. Connections can be made by authorized personnel. Each range has gas, waste and water connections.

Splice Field Joint Installation Instructions:

Range decks have a "tongue and groove" so there is no standing seam between range decks. The decks and backsplashes are joined. The gutters are separate but interlock.

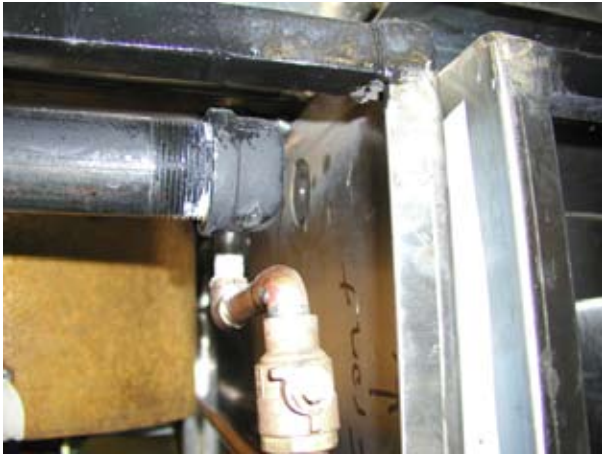

figure 1

1. Uncrate the ranges and place them on pallet jacks. Be careful to position jacks away from drip pan guides.
2. Install the legs onto each range. Secure legs with the set screw in the gusset.
3. Remove the front body panels and serving shelves from both ranges. Figure 1 shows a detail of front right corner of a range with the body front panel removed.



figure 2

4. Carefully move the ranges to their final location. Position the ends to be joined next to each other. The battery was assembled at the factory to assure good fit. Pitched floors will add difficulty to battery assembly.
5. Generously apply silicon to the groove below the stainless steel deck. Apply additional silicon to the tongue of the other range that will fit into this groove. Figure 2 shows the groove.



figure 3

6. Insert the tongue into the groove and slide the ranges together as shown in figure 3.



figure 4

7. Be certain that the range with an extension on its gutter overlaps the gutter of the adjoining range as shown in figure 4.



figure 4



figure 7



figure 5

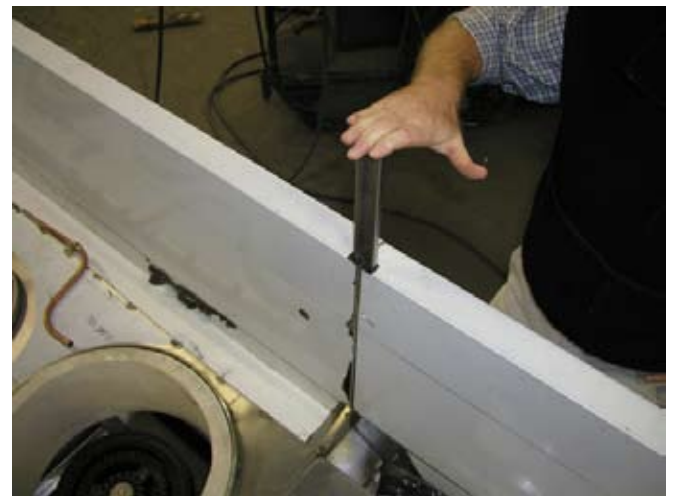

figure 8

8. Locate the bolt holes in the range body as shown above in figures 4 & 5 and bolt the range bodies together.

10. Align the backsplashes. It may necessary to level the range so the backsplashes meet at top. Insert and slide down the "U" shaped joiner until it is level with the top of the backsplash. See figures 7 & 8 above.



figure 6

11. Install the three stainless steel tubes of the wok cover rack. Note there are male and female ends that mate to become a continuous length.

12. Install the serving shelf. There are bolts left, right, and center. The range position may have to be adjusted to allow the bolts to properly align into the tapped holes provided for them.

9. Silicon the front seam of range decks in the circled area of figure 6 above.

13. Pitch the range using the adjustable bullet feet so that water flows off the top of the range.



Dragon Class Chinese Ranges by Town:
Models E, EF, Y, YF, M, MF

Express YORK MASTER RANGE
THE WORLD'S FINEST CHINESE COOKING EQUIPMENT

OWNER'S MANUAL
SECTION 2: OPERATING AND MAINTENANCE INSTRUCTIONS



WARNING

IMPROPER INSTALLATION, ADJUSTMENT, ALTERATION, SERVICE OR MAINTENANCE CAN CAUSE PROPERTY DAMAGE, INJURY OR DEATH. READ THE INSTALLATION, OPERATING AND MAINTENANCE INSTRUCTIONS THOROUGHLY BEFORE INSTALLING OR SERVICING THIS EQUIPMENT.



FOR YOUR SAFETY

DO NOT STORE OR USE GASOLINE OR OTHER FLAMMABLE VAPORS AND LIQUIDS IN THE VICINITY OF THIS OR ANY OTHER APPLIANCE.

NOTE

OBTAIN EMERGENCY PROCEDURES FROM YOUR LOCAL GAS SUPPLIER IF YOU SMELL GAS NEAR THIS EQUIPMENT. THIS EMERGENCY INFORMATION MUST BE PROMINENTLY DISPLAYED.

KEEP THIS BOOKLET HANDY FOR FUTURE REFERENCE



TOWN
FOOD SERVICE EQUIPMENT CO., INC.



72 Beadel St., Brooklyn, NY 11222
(718) 388-5650 fax (718) 388-5860
customerservice@townfood.com

1. The front of the unit must be kept clear to avoid restriction of air supply for combustion.
2. The equipment must be installed with adequate clearance for servicing and proper operation.
3. **This unit should be operated only with drip trays in place.**
4. **UNITS WITHOUT SAFETY VALVES: LIGHTING AND SHUT DOWN INSTRUCTIONS**

Be sure that all piping is gas tight and all air purged from the lines. With main burner valve in "OFF" position (see fig.2), using a screw driver turn pilot screw counter clockwise to "ON" (see fig.1 below) and light pilot located in the combustion chamber. Make sure the pilot stays lit. All units are equipped with fixed orifices which **cannot** be adjusted for gas flow. Ring burners have adjustable air mixers to adjust the air/gas mixture.

Turn right hand burner valve to full "ON" position (see fig.2 below) and adjust air shutter until proper blue flame is burning on both inner rings. Repeat operation for left hand valve only if your range is equipped with three ring burners.

SHUTDOWN:

Turn burner valves to "OFF" position (see fig.2) and turn the pilot screw clockwise (see fig. 1) until it cannot be turned further. Repeat this step for each chambers.

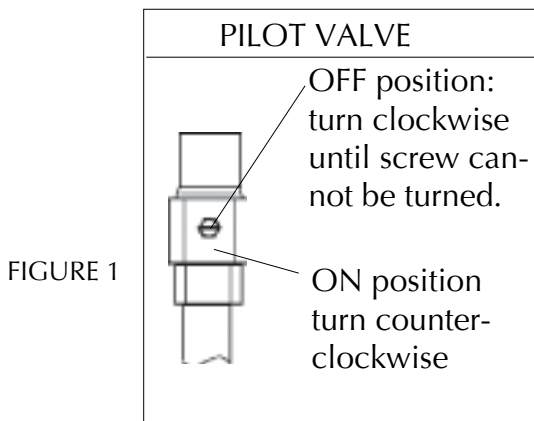

FIGURE 1

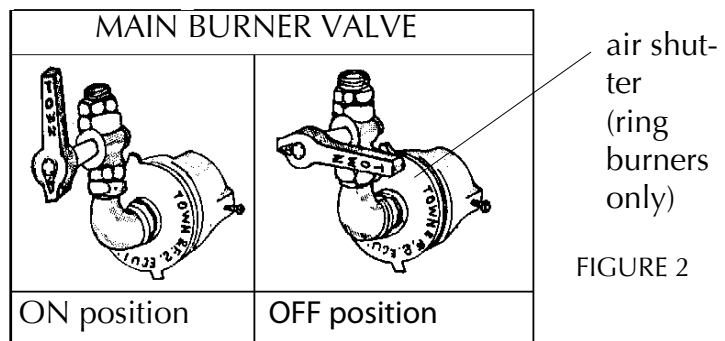

FIGURE 2

5. UNITS WITH SAFETY VALVES: LIGHTING AND SHUT DOWN INSTRUCTIONS.

Always follow these lighting and shutdown instructions when operating your unit. A five minute complete shutoff period is required before lighting or relighting pilot. See diagram below.

- a) Check that all gas valves on the unit are turned "OFF" (see figure 2: lever handles in horizontal position) before turning "ON" main gas line. Check for leaks using soapy water or other suitable leak detector. **DO NOT USE OPEN FLAME FOR TESTING.**
- b) Main burner valve shall be in "OFF" position. Position a burning match by the pilot burner in the combustion chamber of the range. Depress the red button on safety control (see fig.1 below) and light pilot. The pilot should light.
- c) Continue to hold the button for one minute or until the pilot stays lit,

SHUT DOWN: For temporary Shut Down turn all burner valves to "OFF" position.

For an extended period of time, turn all burner valves "OFF" and also turn "OFF" gas supply to the range.

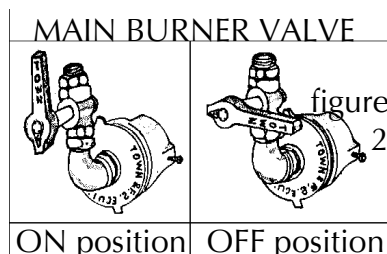
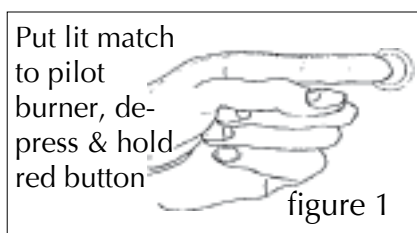

MAINTENANCE AND CARE

- 1) If your equipment requires service, contact your authorized gas service company to perform necessary repairs.
- 2) Check the flue riser monthly to be sure it is free of obstructions. Be sure to clean the air mixers and orifices of ring burners once a year. Jet and shield tip burners must be serviced more often as they become clogged more easily. **This service must be performed by your local qualified gas service company.**
- 3) Your range should be cleaned each evening with grease dissolver and rinsed well. It will prevent grease accumulation and keep the unit clean and sanitary.
- 4) If your unit is supplied with casters, there should be a restraint on the appliance to limit its movement. If disconnection of the restraint becomes necessary, you must be sure to reconnect the restraint after the appliance is returned to its originally installed position.

The following service should be done only by a qualified gas service technician.

5) How to Change The Pilot Light in a chamber with a Ring Burner or Shield Tip Burner:

Shut off pilot valve. The pilot light is mounted on flexible tubing and can be raised. Using a 12 mm open-ended wrench, hold the center of the compression fitting below the pilot firm. Using a 1/2" wrench, unscrew the pilot from its brass fitting at bottom. Install the new pilot by reversing the above procedure. Adjust the pilot flame at the pilot valve and be sure to check for gas leaks using a soapy solution.

Jet burner: Shut off pilot valve. Using a 12mm open-ended wrench, unscrew the pilot, remove and replace. If a 12mm open-ended wrench is unavailable, a 1/2" open end or adjustable wrench may suffice.

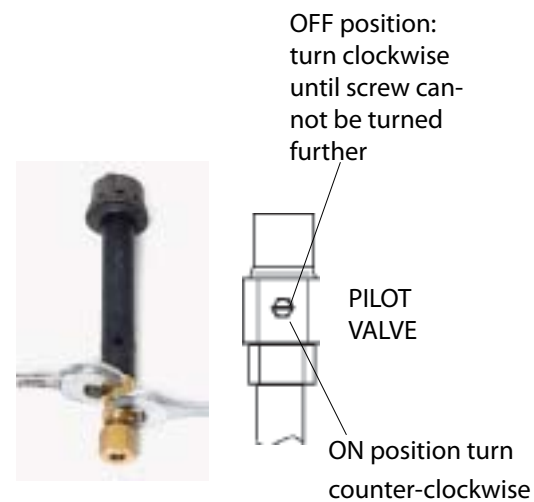

6) Flue Collar Replacement ("F" models)

The cast iron flue collar may deteriorate after considerable use. If you notice such deterioration, we suggest you contact your local service company for replacement parts and qualified service. If you must replace the flue collar yourself, follow the instructions below:

NOTE: Shut off gas to range. The burner and pilot must be removed prior to removing the flue collar.

Remove old nuts behind range that secure flue collar (1). Remove worn collars with pry bar (2). Put new collar into place using provided hardware. Re-cement chamber (see page 11) and replace burner and pilot.

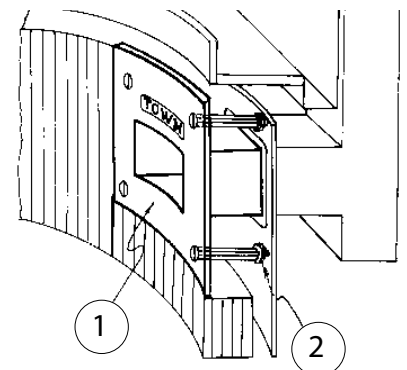
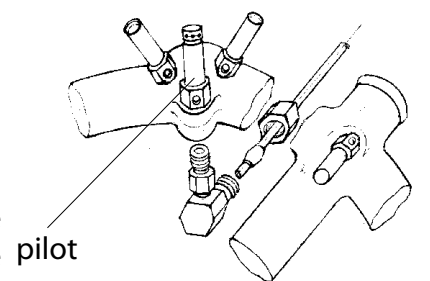

RANGE PARTS

Express/York Replacement Fiber Ceramics

no.	fits chamber	ID	wt
225013N	13"	11"	6
225016N	16"	14"	7
225118N	18"	16"	8
225020N	20"	18"	9
225022N	22"	20"	12

Replacement MasterRRange Fire Bricks

no.	description	wt
225038	13" chamber brick set*	55
225042	16" chamber brick set*	65
225043	18" chamber brick set*	75
225044	20" chamber brick set*	85
225045	22" chamber brick set*	95

Flue Collar and Range Cement

Ranges without Chamber Rings often deteriorate without insulating cement. Use 10 lbs. of cement to recement a chamber.

no.	description	wt
225009	20# can dry cement	20
225010	100# sack dry cement	100
225100	Cast iron flue collar	15

Range Drip Pans All 29 1/4" deep x 1" high

no.	description	wide	wt
227113	Small Galvanized	13"	10
227116	Medium Galvanized	16 1/4"	12
227120	Large Galvanized	19 1/4"	15
227122	Custom Galvanized-to customer's sketch		
227213	Small Stainless	13"	10
227216	Medium Stainless	16 1/4"	12
227220	Large Stainless	19 1/4"	15
227222	Custom Stainless-to customer's sketch		

Stainless Sink Basket Inserts and Frames

no.	description	size: L x W x H	wt
229821	Small frame	19" x 4C\1/2" x 6"	5
229822	Small insert	14" x 4 1/2" x 5C\1/2"	3
229934	Large frame	21 1/2" x 9" x 5M\1/2"	6
229935	Large insert	16" x 8 1/2" x 5C\1/2"	4



* replacement brick set note: advise if chamber has a flue collar when ordering



225009



225100

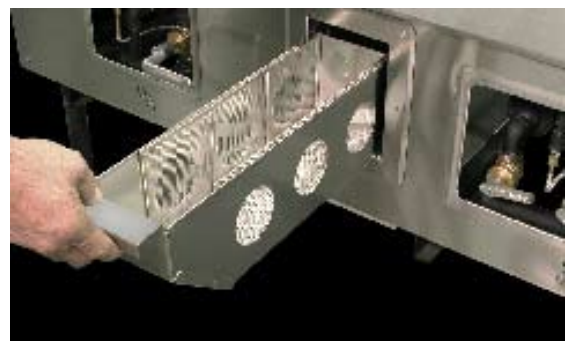

BURNERS & PARTS

Pilot included with burner.

Below burners are 1/2" NPT inlet.



226916
16 tip Volcano



226920
Angle shield tip



226911
Vertical shield tip



23 tip Jet burner



32 tip Jet burner



226917-8



226808



226808H

226916 cleaning kit



226940

226808

226912-4

226808H



226800B



226806N-

226807P



226808



226822



226810-1

16 Tip Volcano Burners

no.	description	wt.
226916N	16 tip Volcano, natural	12
226916P	16 tip Volcano, propane	12
226917	Replacement tip, natural gas	
226918	Replacement tip, propane gas	
226916C	Replacement cover	4
226916N-CLNR	natural gas cleaning kit	
226916P-CLNR	propane gas cleaning kit	
226916B	cleaning brush	
226808H	handle for tip cleaning drill	
226808-60	Tip cleaning drill, natural gas	
226808-73	Tip cleaning drill, propane gas	

Shield Tip Burners

no.	description	wt.
226911N	18 tip vertical shield, natural	10
226911P	18 tip vertical shield, propane	10
226920N	18 tip angle shield, natural	18
226920P	18 tip angle shield, propane	18
226912	Shield tip, natural gas	
226914	Shield tip, propane gas	
226808-57	Shield tip cleaning drill, natural	
226808-72	Shield tip cleaning drill, propane	
226940	Shielded tip wrench	

23 & 32 Tip Jet Burners

no.	description	wt.
226800N	23 tip Jet burner w/ pilot, natural	9
226800P	23 tip Jet burner w/ pilot, propane	9
226804N	32 tip Jet burner w/ pilot, natural	13
226804P	32 tip Jet burner w/ pilot, propane	13
226806N	Jet tip, natural, 1/8" IPS, s/n 58071 up	
226807P	Jet tip, propane, 1/8" IPS, s/n 58071 up	
226806	Jet tip, natural, old type, small thread	
226807	Jet tip, propane, old type, small thread	
226811	Jet pilot, natural	
226810	Jet pilot, propane	
226822	1/8" IPS x 1/4" compression elbow	
226808-60	Jet tip cleaning drill, natural	
226808-72	Jet tip cleaning drill, propane	
226800B	Jet tip cleaning brush	

BURNERS & PARTS

Air Mixer Parts

For two and three ring burners

no.	description
226110	Air Mixer assembly, natural
226111	Air Mixer assembly, propane
226117	Air Mixer orifice, natural
226119	Air Mixer orifice, propane
226115	Air Mixer set screw
226609	3/8" Air Mixer nipple
226526	3/8" Air Mixer street elbow



Ring Burners

no.	description	wt.
226130	2 ring burner/nipple for range	14
226131	3 ring burner/nipples for range	30
226130-18	2 ring burner/nipple for SR-18	14
226131-24	3 ring burner/nipples for SR-24	30



Safety Pilot Parts for Ranges

no.	description
249002	1/2" IPS Safety, pilot out only, TS11K
249003	3/8" IPS Safety, pilot in & out, TS11J
249006	36" thermocouple
226203B	Universal pilot bracket, s/n 58071 up

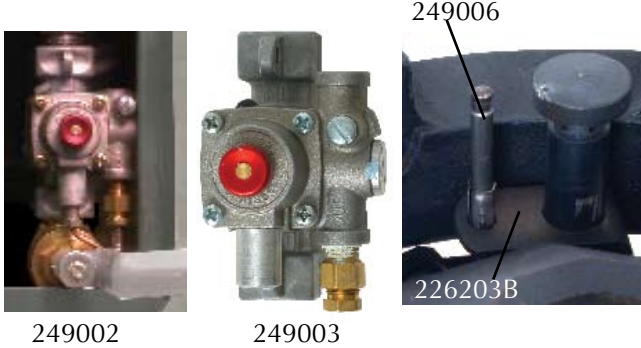

9 & 12 Tip Anti-Clog Volcano Burner

Available on new ranges only. Not sold separately.

no.	description	wt.
226950N	9 tip No-Clog, natural	25
226950P	9 tip No-Clog, propane	25
226960N	12 tip No-Clog, natural	25
226960P	12 tip No-Clog, propane	25
226952	Replacement tip, natural	
226953	Replacement tip, propane	
226950C	No-Clog burner cover	10
226808-56	Tip cleaner, natural	
226808-70	Tip cleaning drill, propane, 9 tip	
226808-71	Tip cleaning drill, propane, 12 tip	



REPLACEMENT PARTS

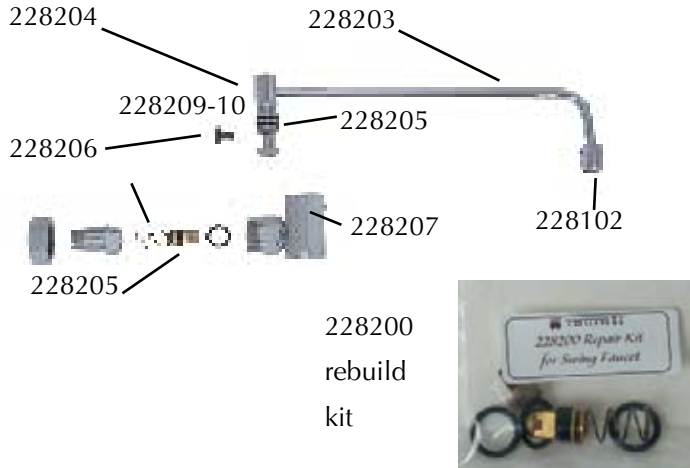

226202NT
226203PT
For three ring
burners



226202N
226203P
for all other
burners



Autoflo™...the Original Swing Faucet Be-ware of imitations!

One piece cast brass body and heat proof internal parts let our faucet outlast all others. Look for "AutoFlo" stamped on the faucet.

Swing Faucet Parts

no.	description	wt
228000	3/8" Swing Faucet, complete	3
Swing Faucet Parts		
no	description	
228102	Aerator	
228203	Spout	
228204	Spindle	
228205	"O" rings	
228206	Water switch	
228207	Screw	
228209	Spring washer	
228210	Replacement washer	
228205	Union washer	
228200	Repair kit: includes 1 each E, G, I, & 2 pcs. D	

Pilot Burners & Parts

no.	description
226202N	Anti-clog pilot, nat gas
226203P	Anti-clog pilot, propane gas
226202NT	Anti-clog Ring Burner pilot, nat gas
226203PT	Anti-clog Ring Burner pilot, prop gas
226824	1/8" IPS x 1/4" compression coupling
226204	Anti-clog pilot orifice, nat gas
226205	Anti-clog pilot orifice, propane gas
226203B	Universal pilot bracket, s/n 58071 up

Gas Valves

no.	description
226102F	3/8" x 3/8" F Gas valve
226104F	1/2" x 1/2" F Gas valve (older ranges)
226104M	1/2" x 1/2" M Gas valve
226103	Handle for 3/8" valve
226105	Handle for 1/2" gas valve
226224	24" x 1/4" s/s compression pilot tubing
226201	1/4" compression x 1/8" IPS pilot valve

Range Manual Nov. 06